

# TALOS™ I

## Integrated

## Solar

## Street Light

**E-LITE** semicon

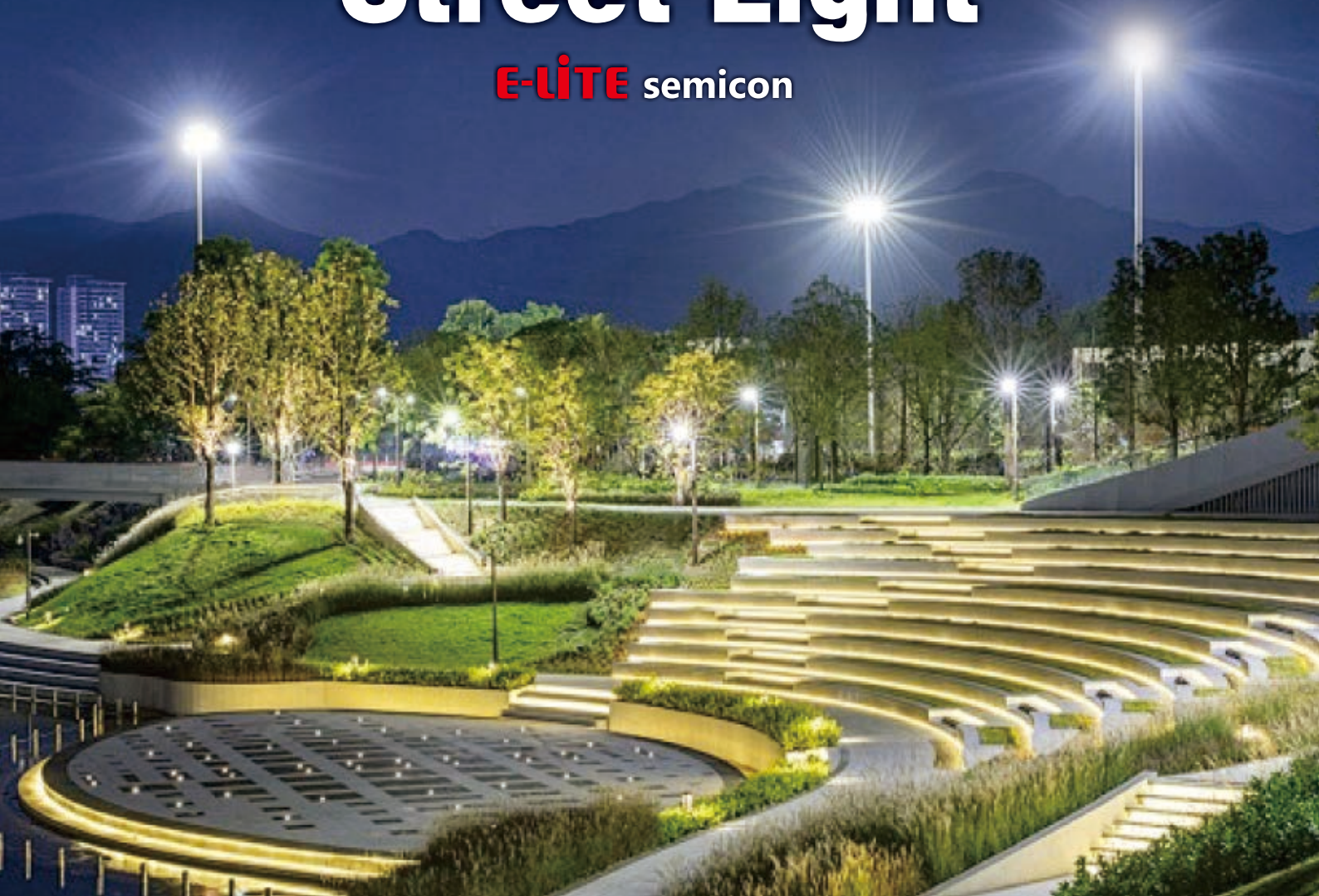





## **THE COMBINATION OF SIMPLICITY ELEGANCE AND DURABILITY**

Harnessing the power of the sun, the all-in-one Talos I solar luminaire delivers zero carbon illumination to brighten your streets, pathways, and public spaces. It stands apart with its originality and solid construction, seamlessly integrating solar panels and large battery to provide real and continuous high brightness output for long operation hours.

Embrace the future of sustainable lighting with Talos I , where style meets substance in a beautiful, efficient package.



## KEY FEATURES



Premium-grade integrated all-in-one design, easy to install and maintain.



Environment friendly & electric bill free - 100% powered by the sun.



No trenching or cabling work needed.



Light on/off and dimming programmable smart lighting.



High luminous efficiency of 190~210lm/W to maximize battery performance.



Pivoting LED modules deliver the best lighting control.



IP66 Luminaire ensures long lasting and consistent high performance.



Five Years Warranty.







## APPLICATIONS

- Street Lighting
- Roadway Lighting
- Pathway Lighting
- Ramp Lighting
- Sidewalk Lighting
- Private Road Lighting
- Farm Lighting
- Wildlife Area Lighting
- Perimeter Security
- Lighting
- Park Lighting
- Railway Yard Lighting
- Fence Lighting
- Campus Lighting
- Ship Dock Lighting
- Remote Area Lighting
- Military Base Lighting
- Gate Lighting
- Jogging Path Lighting

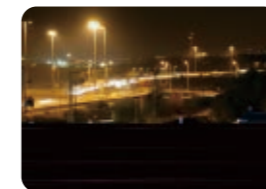



## RELIABILITY UNEXPECTED VALUE



Only top quality mono - crystalline silicon solar panels with high efficiency and long lifetime are used.



Quality lithium batteries are used to store the energy, provide energy for immediate requirements, and enable a back-up for days when there is little or no sun.



High Lumen LED for maximum efficacy. Dedicated designed low-voltage solar controller technology with dimming capabilities for power-save management.  
Lifetime > 50,000 hrs and CRI nominal 70.



Microprocessor managed algorithms autonomously determine sunrise and sunset.



Easy to install without buying cables and rectifiers, directly on pole with an adjustable spigot  $0^{\circ}$  ~ $90^{\circ}$  .







## **STAY POWERFUL THE DC CHARGE PORT**

A DC charge port is offered as an option to be integrated into Talos I , ensuring the battery remains charged even during extended periods in the warehouse. No more worrying about flat batteries when you need them the most. Embrace the continuous and dependable lighting with our state-of-the-art Talos I solar street light.



# PHOTOMETRICS

60×100° (TYPE I -VS)

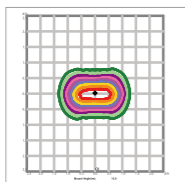
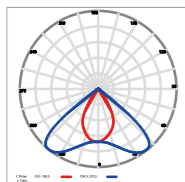

70×135° (TYPE II -S)

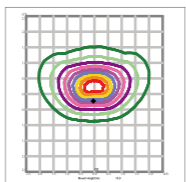
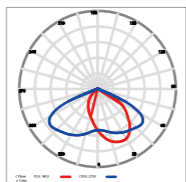

75×150° (TYPE III -M)

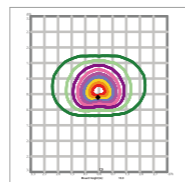
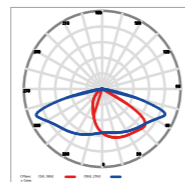

80×150° (TYPE III -S)

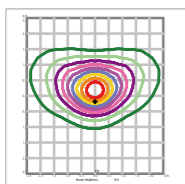
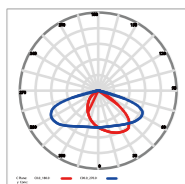

110° (TYPE V -VS)

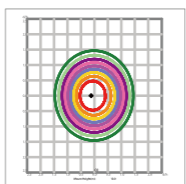
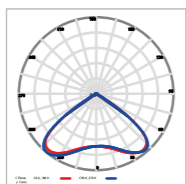

150° (TYPE V -VS)

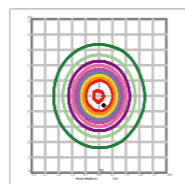
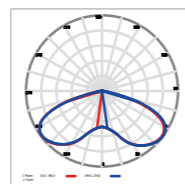



# PERFORMANCE



20W~90W



190~210lm/W



Philips Lumileds



PIR & Microwave & Timer Dimming



MPPT / PWM Controller



5000K ( 2500~6500K optional )



60×100° / 70×135° / 75×150° / 80×150° / 110° / 150°



IP66



IK08



Monocrystalline silicon photovoltaic panels



LiFeP04 battery



Slip fitter



Operating Temperature:-20°C to +60°C / -4°F to 140°F (Charge:0°C to 60°C / 32°F to 140°F & Discharge:-20°C to 60°C / -4°F to 140°F)  
Storing Temperature:-20°C to +60°C / -4°F to 140°F



# SPECIFICATIONS

Part#	Power	Modules	LED Efficacy		Solar Panel	Battery		Product Dimensions
			High Brightness Version	Standard Version		Standard	Premium	
EL-TAST I -20	20W	1	220 lm/W	200 lm/W	40W/18V	12.8V/12AH	12.8V/18AH	690×370×287mm
EL-TAST I -30	30W	1	217 lm/W	200 lm/W	55W/18V	12.8V/18AH	12.8V/24AH	958×370×287mm
EL-TAST I -40	40W	1	213 lm/W	195 lm/W	55W/18V	12.8V/18AH	12.8V/24AH	958×370×287mm
EL-TAST I -50	50W	1	210 lm/W	190 lm/W	65W/18V	12.8V/24AH	12.8V/30AH	1070×370×287mm
EL-TAST I -60	60W	1	207 lm/W	185 lm/W	75W/18V	12.8V/24AH	12.8V/30AH	1270×370×287mm
EL-TAST I -80	80W	2	213 lm/W	195 lm/W	105W/36V	25.6V/18AH	25.6V/24AH	1170×550×287mm
EL-TAST I -90	90W	2	210 lm/W	195 lm/W	105W/36V	25.6V/18AH	25.6V/24AH	1170×550×287mm

The solar panel and battery configuration is based on 6 hours charging time.



# SOLAR CONTROLLER - A

## E-Lite Self Proprietary MPPT Controller

1 >>

### Constant Mode

Light will automatically turn on at dusk and keep constant 45% brightness in a set power in the period.

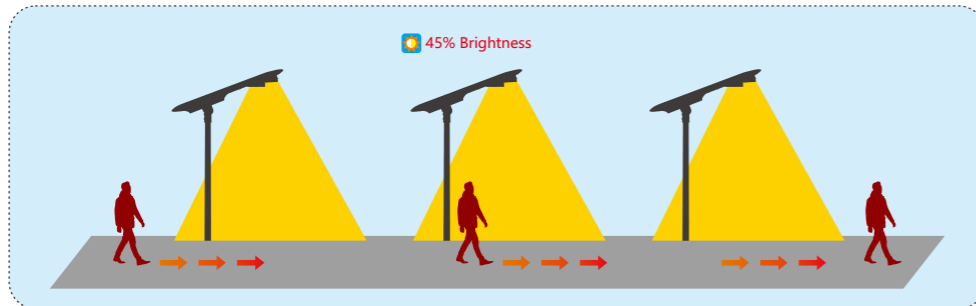

2 >>

### Dusk to Dawn Mode

Automatically turns on at dusk and remains at up to 100% brightness for 4 hours, then it automatically turns to 30% brightness until dawn.



3 >>

### Motion Sensor Mode

Automatically operates at 30% brightness. When motion is detected, light increases to 100% until no motion is detected for 30 seconds, then returns to 30% brightness.

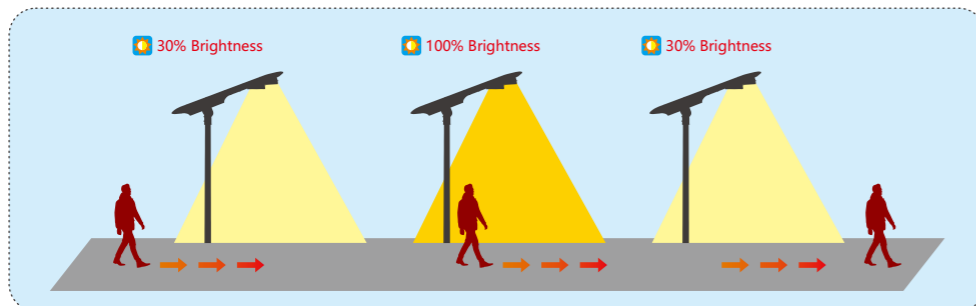

4 >>

### T1 Mode

Motion: 2 hrs-100%; 3 hrs-60%; 4 hrs-30%; 3 hrs-70%;  
Without Motion: 2 hrs-30%; 3 hrs-20%; 4 hrs-10%; 3 hrs-20%;

	2 hrs	3 hrs	4 hrs	3 hrs
Motion	100% Brightness	60% Brightness	30% Brightness	70% Brightness
Without Motion	30% Brightness	20% Brightness	10% Brightness	20% Brightness

5 >>

### T2 Mode

Motion: 2 hrs-100%; 4 hrs-60%; 6 hrs-40%;  
Without Motion: 2 hrs-100%; 4 hrs-20%; 6 hrs-10%;

	2 hrs	4 hrs	6 hrs
Motion	100% Brightness	60% Brightness	40% Brightness
Without Motion	100% Brightness	20% Brightness	10% Brightness







## SOLAR CONTROLLER - B

### Regular MPPT Controller



#### Five-Stage Mode

The lamps lighting divide into 5 stage, each stage time and dim can be setting according to demands. With diming setting, it is an efficient way to save energy, and keep the lamp working in best power and time.

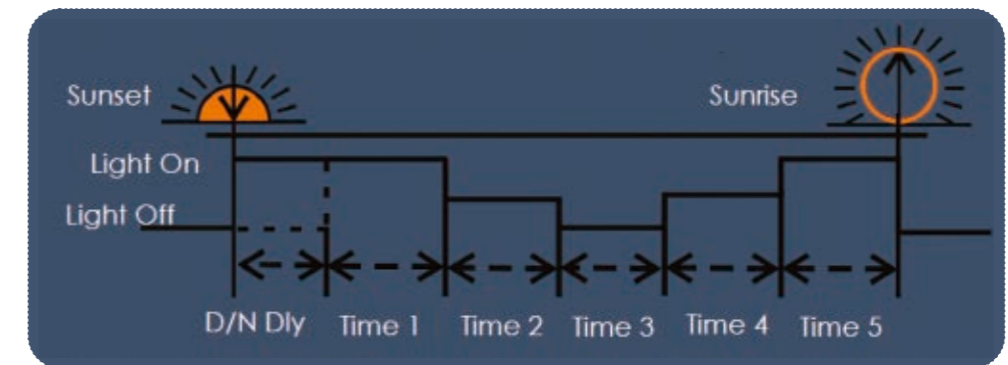

#### Motion Sensor Mode

Motion: 2 hrs-100%; 3 hrs-60%; 4 hrs-30%; 3 hrs-70%;

Without Motion: 2 hrs-30%; 3 hrs-20%; 4 hrs-10%; 3 hrs-20%;

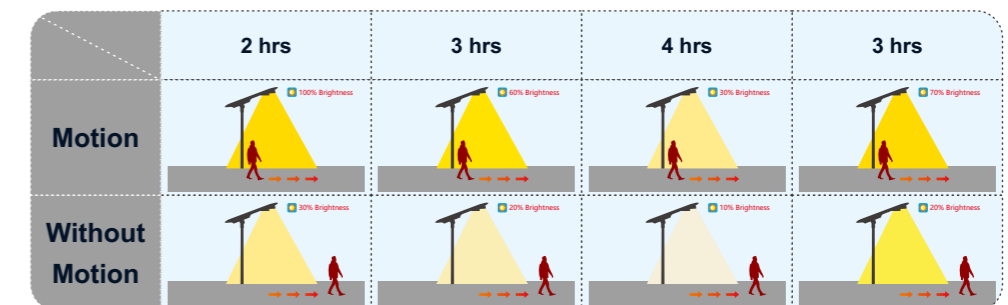



# SOLAR CONTROLLER - C

## Hybrid MPPT Controller



### Dusk to Dawn (D2D)

When fixture is set to D2D, it works in dusk to dawn mode. The fixture will turn on while the sun is down, as determined by the solar panel voltage.

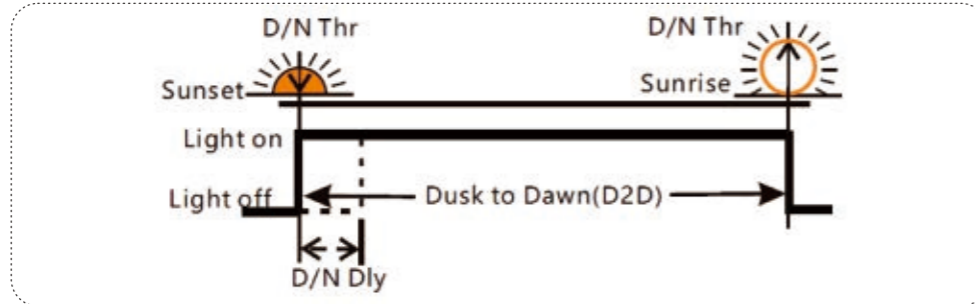

### Five-stage Night Mode

The lamps lighting divide into 5 stage, each stage time and dim can be setting according to demands. With dimming setting, it is an efficient way to save energy, and keep the lamp working in best power and time.

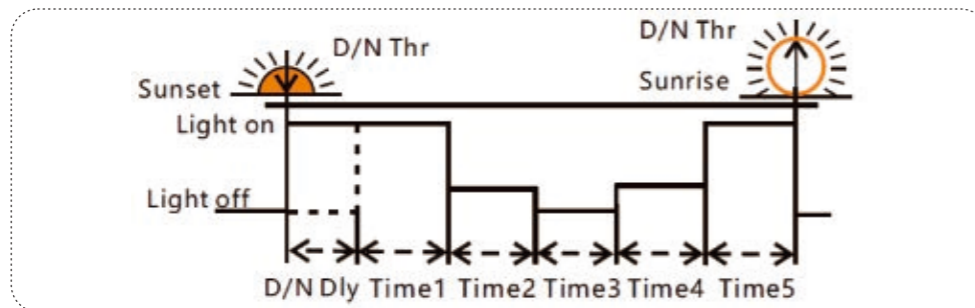

### TOT Mode (Can set the load on time before morning coming.)

When fixture is set to TOT then it will determine Time4 based on Time5 and previous data on the time of sunrise.

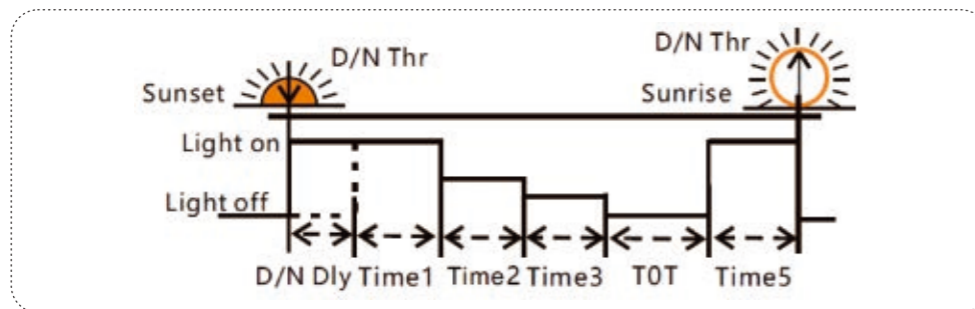





## INSTALLATION NOTES

1. Due to variations in longitude and latitude at the installation site, the angle at which the sun's rays illuminate differs. During installation, it is crucial for the solar panel to be oriented towards the sun precisely at 12:00 noon. However, often due to factors like road direction and light poles, achieving this alignment becomes challenging. The solar panel must still maintain a horizontal position even if it can't be ideally oriented towards the sun at noon due to road lighting requirements.

Several conditions can lead to suboptimal functioning of standard lamps. Prior to making a purchase, it's important to communicate these factors to the salesperson and consider increasing the solar panel's power capacity:

a. Any deviation below the horizontal plane of the solar panel, relative to the solar irradiation angle, will result in a significant decline in the solar panel's power generation efficiency.

b. When installing solar lamps and lanterns, it's essential to avoid any obstacles that might block sunlight, such as trees or buildings.

c. Natural elements like rain, ice, snow, dust, clouds, and bird droppings can reduce the solar panel's power generation efficiency.

Ensuring that the solar panel remains unobstructed by barriers like trees and buildings, and accounting for factors such as the solar panel's angle and external elements, are vital for optimal performance.

2. Install lamps at a considerable distance from areas prone to strong electromagnetic interference, such as high-voltage cables and high-power wireless transmission towers. These sources could potentially disrupt the lamp control system, leading to malfunctions and improper operation.

3. When the temperature drops below 0°C, the efficiency of lithium iron phosphate batteries for charge and discharge decreases. To prevent damage and the battery protection triggered by over-discharge, it's advisable to explain this to the sales

staff and consider increasing battery capacity before making a purchase.

4. Any environmental impact can result in a decline in the efficiency of solar panel power generation. Repeated discharge of the lithium iron phosphate battery might easily activate the protection mechanism, causing the lamps to stop functioning normally. Most lithium batteries can be restored to operation by disconnecting and reconnecting the battery-light source connection and the solar panel connection.

5. Once the battery protection has been deactivated and reactivated, our focus should be on identifying and resolving any natural environmental factors that compromise the efficiency of solar panel power generation, as well as minimizing the power consumption of the light source.

6. Install the lamps on days abundant with sunshine. The lamps are initially set to 30% power upon leaving the factory. Prior to installation and usage, ensure that the lamps can receive effective sunlight charging for at least 4 hours after activation. Failure to do so may trigger battery startup stress protection due to excessive discharge, leading to abnormal lamp operation.

7. The self-discharge and stress protection features of the lithium iron phosphate battery necessitate that if the lamp remains unused and uninstalled for a period of 60 to 90 days from the factory departure, it must undergo a 4-hour effective sun charging upon activation.

Instances where lamp functionality is compromised due to the aforementioned circumstances are not included in the warranty coverage. However, we are committed to assisting customers in identifying and analyzing the underlying causes, and devising plans for enhancements. It's important to note that lamps unable to activate after battery protection will not be covered by the warranty.



# iNET SMART CONTROL SYSTEM



## Smart City

Smart controlling perfectly combines the solar street lighting fixture, internet of things with wireless communication technology, achieve monitoring and management of remote background data, real-time understand the normal working status of each component of solar energy (street lights, photovoltaic panels, batteries, controllers), allow you to know the product usage on the client terminal that is thousands of miles away without leaving home or to manage the opening and closing of street lights and the adjustment of bright spot power on me.

- The solar street light management system can pre-set one or more lighting modes according to the different time of day and traffic flow, automatically turn on or off any light, and adjust the switching time and illumination according to environmental requirements to achieve the purpose of energy-saving and consumption reducing.

- The integrated system is mainly composed of a street light component a centralized controller, a single light controller, and a smart cloud platform. The centralized controller and the single light controller aggregate the data collected by the single light via the RF wireless communication network. The centralized controller uploads data to the system cloud platform through GPRS data flow, providing data dependence for mobile phone and computer terminal access.

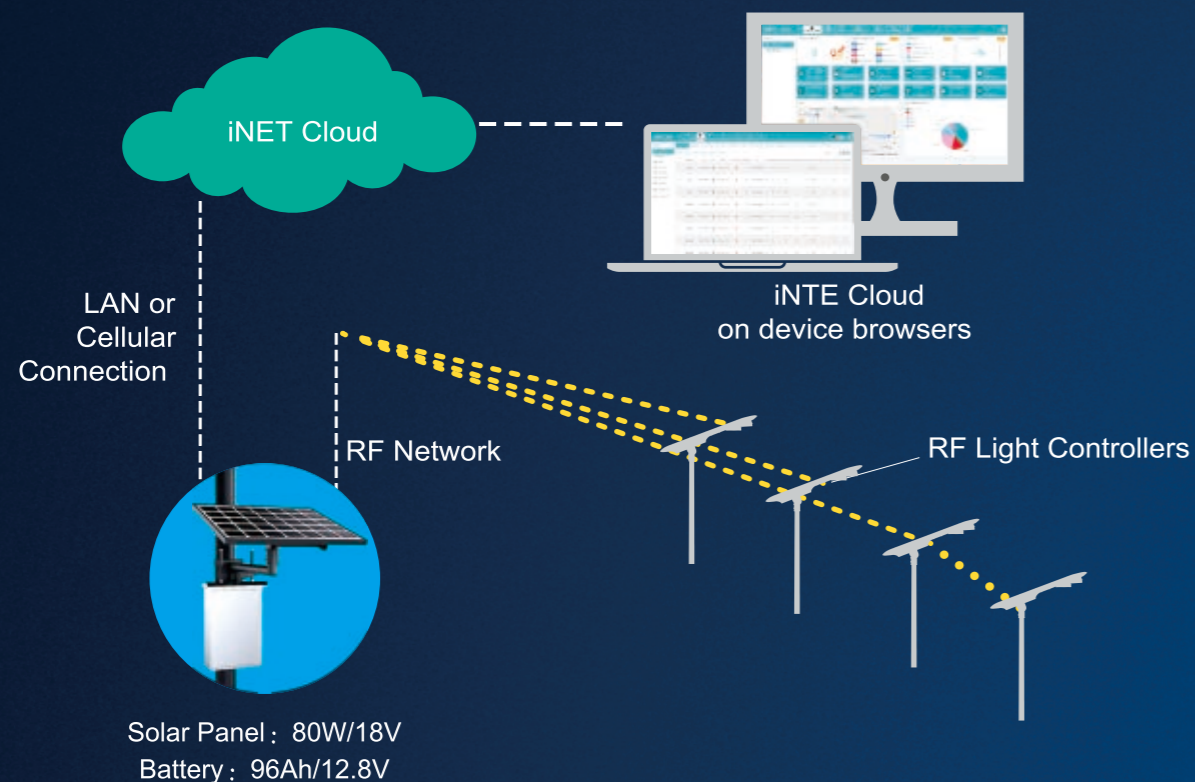

## System & Hardwares



### Automatic Light On/Off & Dimming Control

- By time setting
- On/off or dimming with motion sensor detection
- On/off or dimming with photocell detection



### Accurate Operation & Fault Monitor

- Real-time monitor on each light working status
- Accurate report on fault detected
- Provide location of fault, no patrol required
- Collect each light operation data, such as voltage, current, power consumption



### Extra I/O Ports for Sensor Expandability

- Environment Monitor
- Traffic Monitor
- Security Surveillance
- Seismic Activities Monitor



### Reliable Mesh Network

- Self proprietary wireless control node
- Reliable node to node, gateway to node communication
- Up to 1000 nodes per network
- Max. network diameter 2000m



### Easy-to-use Platform

- Easy monitor on each and all lights status
- Support lighting policy remote set-up
- Cloud server accessible from computer or hand held device



# ORDERING INFORMATION

