

Durable Lighting Made for Industrial Safety



Hazardous Location LED Luminaire STA1/STA2 Series

Specsheet-2023-07 EN

VENAS
Venas International Co., Ltd

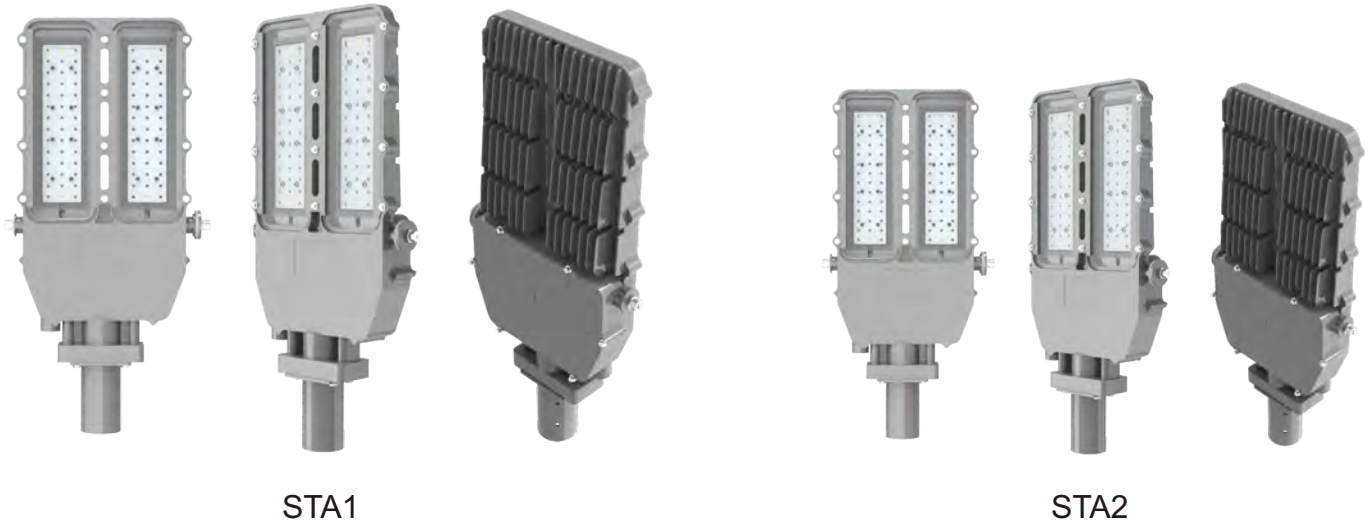

Product Description

The STA1/STA2 Series LED fixture is the ideal choice for marine and hazardous applications. They can be used in locations where moisture, dirt, dust, corrosion and vibration may be present, or areas where wind, water, snow or high ambient can be expected.

Features

- Suitable for Zone 1&2 (Gas), Zone 21&22 (Dust)
- High luminous efficacy - Up to 120-140 lumens per watt
- 0-10V dimming
- Waterproof and dust-proof, without internal cleaning and maintenance
- Simple structure for easy and quick installation
- Stainless steel fasteners, ADC12 aluminum housing, good corrosion resistance
- Tempered glass, high light transmittance and impact resistance

Compliance

ATEX Standard (Zone 1):

⊕ II 2 G Ex eb mb IIC T6...T4 Gb

⊕ II 2 D Ex tb IIIC T95°C...T125°C Db IP66

ATEX Standard (Zone 2):

⊕ II 3G Ex ec mb IIC T6...T4 Gc

⊕ II 2D Ex tb IIIC T80°C...T125°C Db

IECEX Standard (Zone 1):

Ex eb mb IIC T6...T4 Gb

Ex tb IIIC T95°C...T125°C Db IP66

IECEX Standard (Zone 2):

Ex ec mb IIC T6...T4 Gc

Ex tb IIIC T80°C...T125°C Db

Class I Zone 2 Group IIC

Class II Zone 21 Group IIIC

IP66/IP67

IK06/07 (without wire guard)

IK09 (with wire guard)

1000 hours salt spray

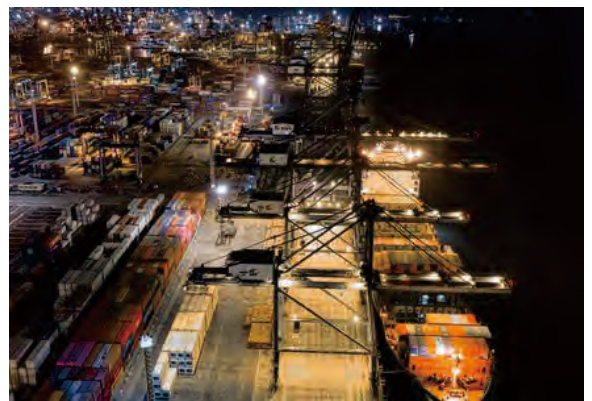

Application

- Power Plants
- Heavy Industrials Storage Facility
- Paper mills
- Wastewater Treatment Plants
- Loading Docks Platforms
- Offshore Environments
- Chemical Processing Facility
- Petrochemical Processing Facility
- Metallurgical Industry
- Coal Mine
- Food and Alcohol industry



Warranty

5-Year Standard Warranty

LED lumen Maintenance: L70> 150,000 Operation Hours@55°C

Technical Parameter

• Electrical

Specification	EX-xxxW STA1YZD	EX-xxxW STA2YZD
Rated Power	Max 200W	Max 150W
Input Voltage	AC120-277V	AC120-277V
Input Frequency	50/60Hz	50/60Hz

• Optical

Specification	EX-xxxW STA1YZD	EX-xxxW STA2YZD
Lumen Output	Max 28,000lm	Max 21,000lm
Lumens Per Watt	120-140lm/W	120-140lm/W
CCT	2700K-7000K	2700K-7000K
CRI	> 70	≥70
Beam Angle	40°/60°/90°/120°/T3/T5	40°/60°/90°/120°/T3/T5
Dimming	0-10V dimming	0-10V dimming

• Environmental

Specification	EX-xxxW STA1YZD	EX-xxxW STA2YZD
Ambient Operating Temperature	-40°C to +55°C (-40°F to +131°F)	-40°C to +55°C (-40°F to +131°F)

• Mechanical

Specification	EX-xxxW STA1YZD	EX-xxxW STA2YZD
Housing Material	ADC12 aluminum	ADC12 aluminum
Glass	Tempered glass	Tempered glass
Surface	Explosion-proof joint surface	Explosion-proof joint surface
Fasteners	Stainless steel	Stainless steel
Protection	IP66/IP67 IK06/07 (without wire guard)/IK09 (with wire guard)	IP66/IP67 IK06/07 (without wire guard)/IK09 (with wire guard)
Mounting	Pole, Trunnion, Arm, Slip Fitter, Bracket, Stanchion	Pole, Trunnion, Arm, Slip Fitter, Bracket, Stanchion

Product Dimensions

EX-xxxW STA1YZD

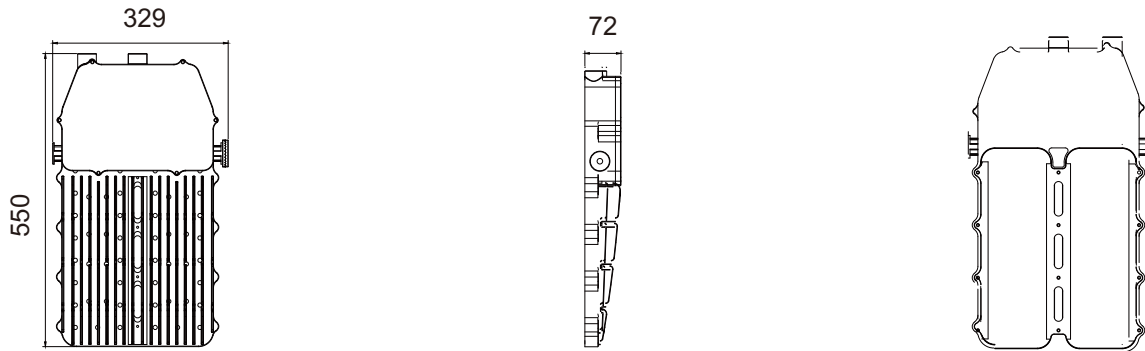

EX-xxxW STA2YZD

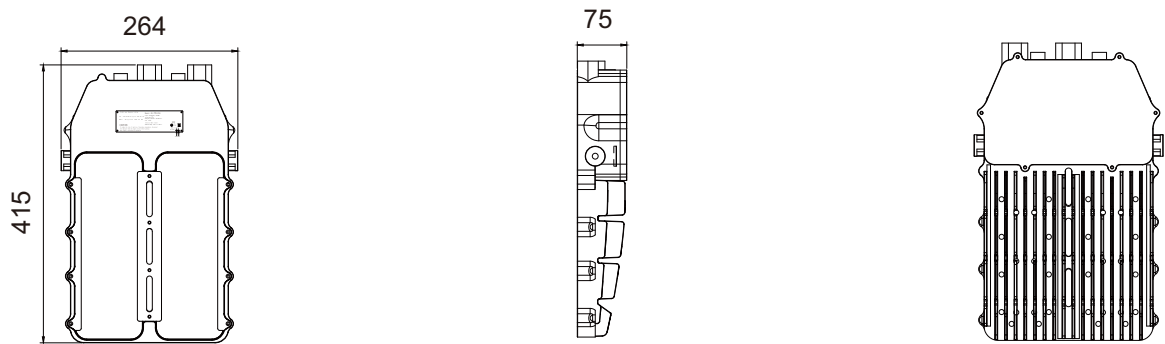

- Packing Information

Model	Net Weight (Product)	Product Dimensions (LxWxH)	Quantity/ Carton	Gross Weight	Package Dimensions (LxWxH)
EX-xxxW STA1YZD	9.5kg/20.94lb	550x329x72mm/ 21.65x12.95x2.83inch	1 pc	10.5kg/23.15lb	855x375x226mm/ 33.66x14.76x8.89inch
EX-xxxW STA2YZD	6.5kg/14.33lb	415x264x75mm/ 16.34x10.39x2.95inch	1 pc	7.5kg/16.53lb	560x320x127mm/ 22.05x12.60x5.00inch

Photometric

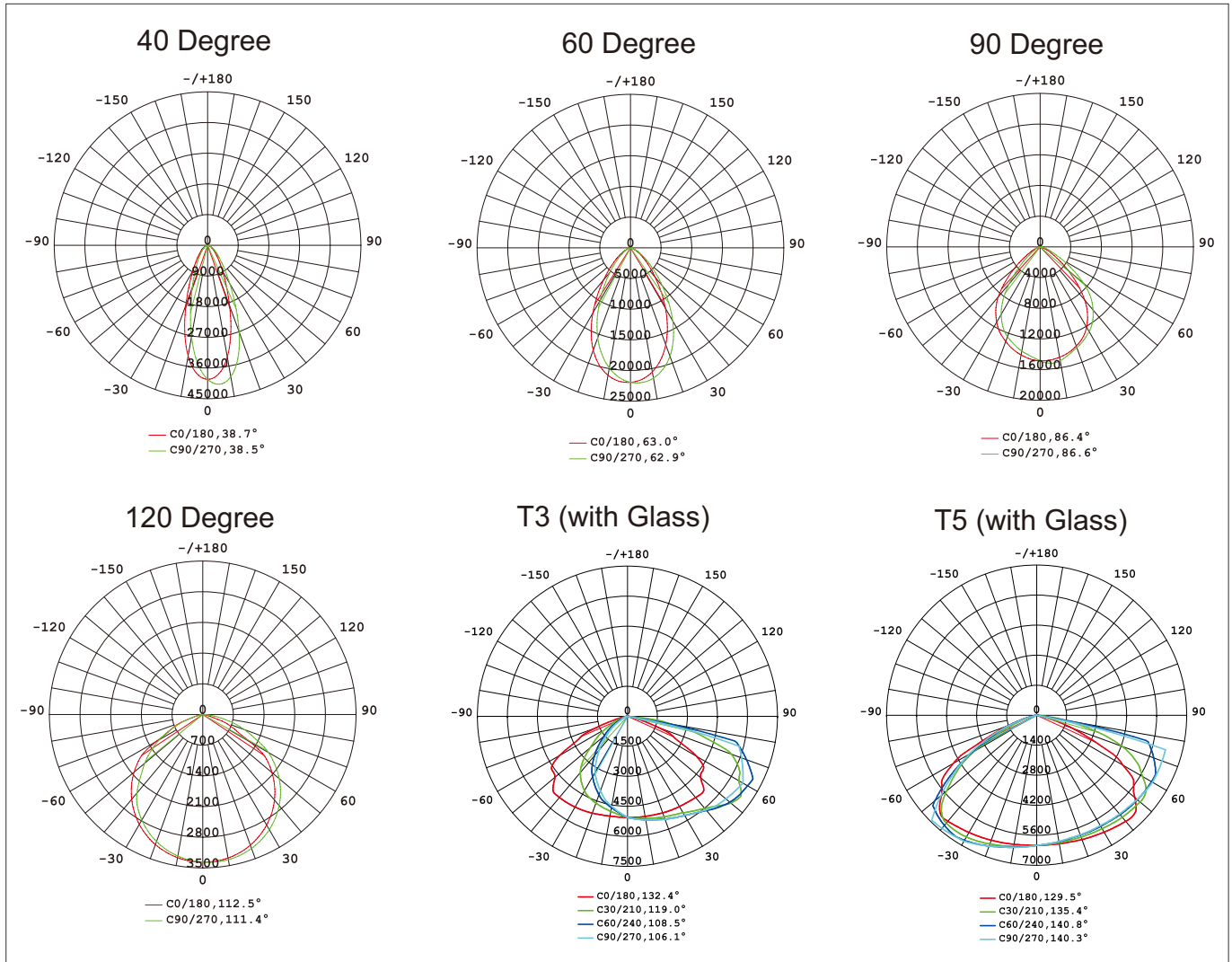

Ordering Guide

EX - xxxW STAx Y Z D

EX: Explosion proof light

xxxW: Wattage. STA1: Max 200W, STA2: Max 150W

STAx: Product code. Can be STA1, STA2

Y: Dimming option. D=dimmable, N=non-dimmable

Z: CCT. Can be 27 to 70, denotes 2700K to 7000K

D: Beam angle. D40=40°, D60=60°, D90=90°, D120=120°, T3=T3, T5=T5

Mounting Methods and Accessories

• Option 1: Pole Mounting

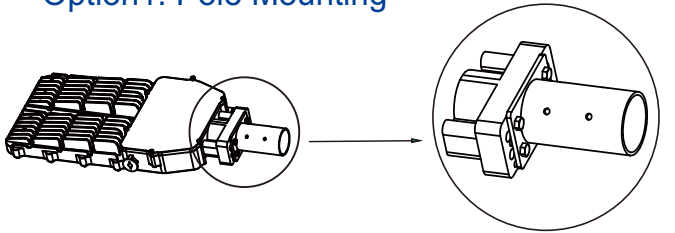

Adapter bracket & Light pole mounting bracket

• Accessories



Adapter bracket



Light pole mounting bracket

• Option 2: Trunnion Mounting

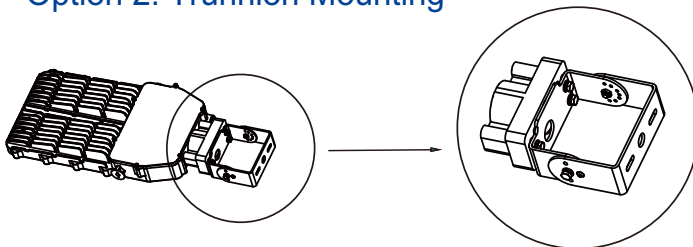

Adapter bracket & Trunnion mounting kit

• Accessories

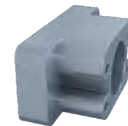

Adapter bracket



Trunnion mounting kit

• Option 3: Arm Mounting (A)

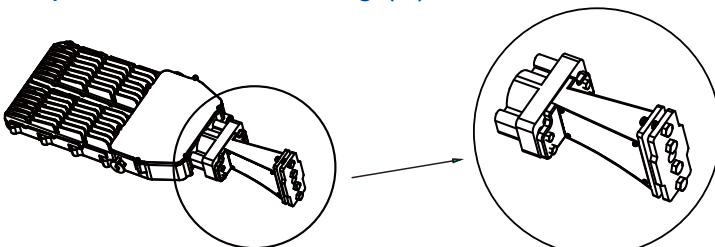

Adapter bracket & Arm mounting kit A

• Accessories

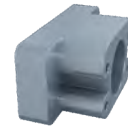

Adapter bracket



Arm mounting kit A

• Option 4: Arm Mounting (B)

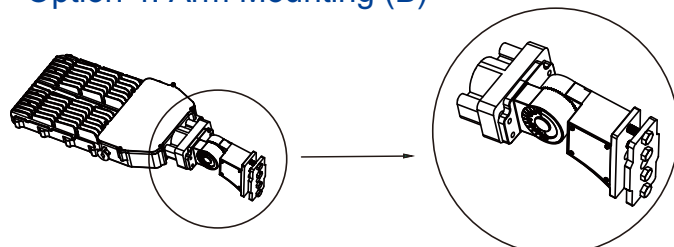

Adapter bracket & Adjustable arm mounting kit B

• Accessories

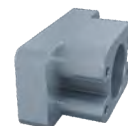

Adapter bracket



Adjustable arm mounting kit B

Mounting Methods and Accessories

• Option 5: Slip Fitter Mounting

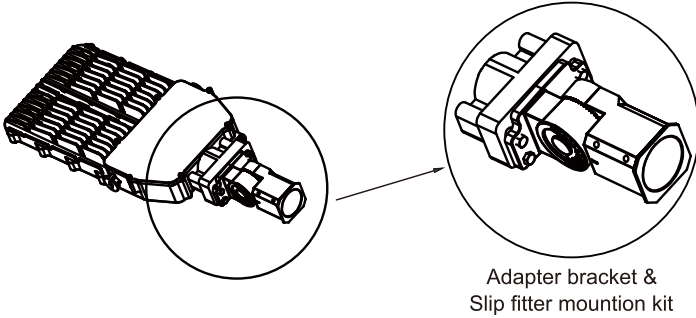

• Accessories

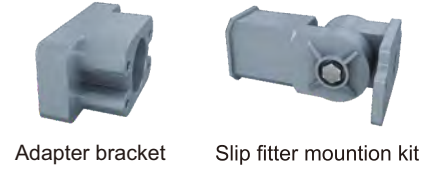

• Option 6: Bracket Mounting

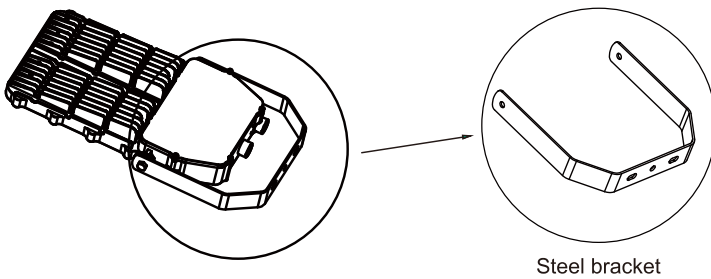

• Accessory

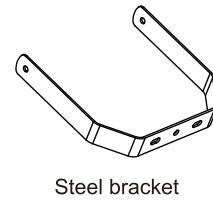

• Option 7: Stanchion Mounting

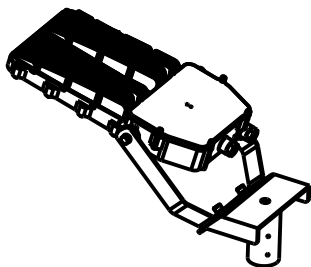

• Accessory

