

CLP-5001

Architectural LED Lighting
DESIGN-FUNCTION-QUALITY



Crystal Lighting Corp.





CLP-5001 Slim LED Architectural light post top fixture, suitable for wet locations. Perfect for lighting up residential exteriors, walkways, perimeters, school campuses, Industrial/commercial spaces, parking lots, recreational parks. This fixture has a wide light distribution.

- Dark sky compliant
- 10 year/100,000 hour limited warranty.

FEATURES:

- Energy Savings: Over 66% compared to HID light sources
- Improved lumen maintenance
- Utilizes high efficient Lumiled LED's
- Operating temperatures: -30°C ~ 60°C
- Driver: Constant current, 120-277v, 50/60Hz, 480v (Optional)
- Suitable for wet locations
- 0-10 Dimming, occupancy sensors, photo cell and wireless controls capable (optional)

CONSTRUCTION:

- Housing is spun aluminum material
- Powder coat black and white finish (standard) various colors available (custom).
- Clear Optic System (Standard)
- Silicone gasket to prevent leakage and provide weather-tight protection.
- Mounting: over of a 3" O.D Tenon or Pole (standard) (Adapter is Required for other mounting sizes)

OPTIC DISTRIBUTION

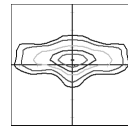

TYPE 2 (T2)

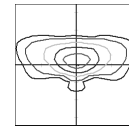

TYPE 3 (T3)

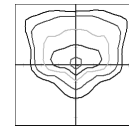

TYPE 4 (T4)

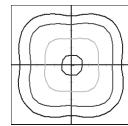

TYPE 5 (T5)



Example: CLP-5001-TP1-3B-T2-40K-MV-BRZ-OCC



Cat #	Top	Mounting	Light Dist.	Wattage	Color Temp.	Voltage	Color	Options
CLP-5001S	TOP 1 (TP1)	Arm Mount (AM)	Type 2 (T2)	20W (20CLELED)	3000K (30K)	120-277V (MV)	Black (BLK)	Occupancy Sensor (OCC)
	TOP 2 (TP2)	3 Bars (3B)	Type 3 (T3)	40W (40CLELED)	4000K (40K)	480V (48)	White (WH)	Button Photo Cell (PC)
			Type 4 (T4)	50W (50CLELED)	5000K (50K)		Bronze (BRZ)	Wireless controls (WC)
		2 Side Bars (2SB)	Type 5 (T5)	60W (60CLELED)	6500K (65K)	Silver (SIL)	Acrylic Drop Lens (ADL)	
				70W (70CLELED)		Graphite (GPH)		
						Marine Grade (MG)		

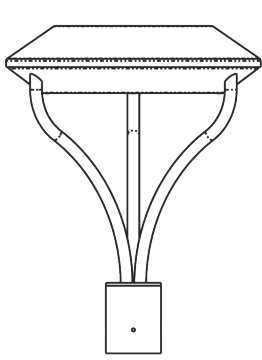

CLP-5001-TP1-3B

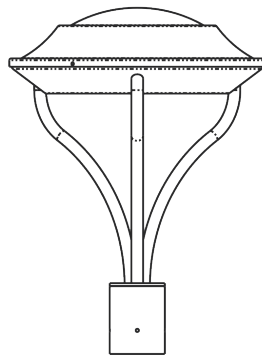

CLP-5001-TP2-3B

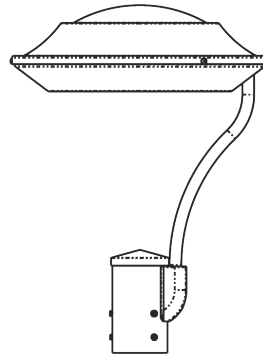

CLP-5001-TP2-2SB

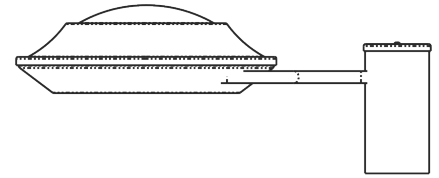

CLP-5001-AM

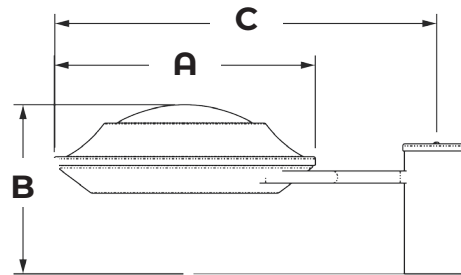
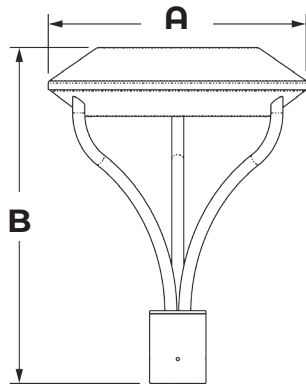
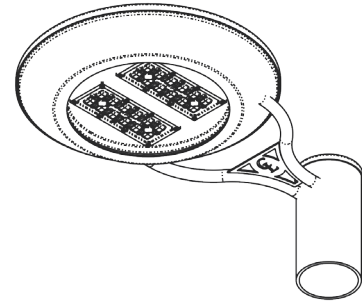
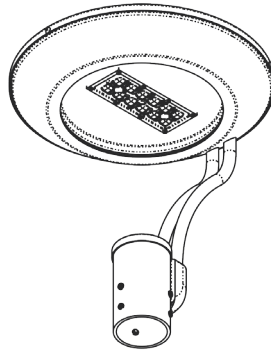
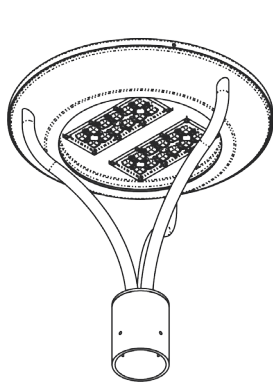

Dimensions				
Cat#	A	B	C	εPA
CLP-5001S-TP1-3B	16" 1/8	20" 7/8	-	.64
CLP-5001S-T2-3B	16" 1/8	20" 7/8	-	.68
CLP-5001S-T2-2SB	16" 1/8	20" 7/8	-	.67
CLP-5001S-AM	16" 1/8	10" 1/2	23" 7/8	.55

Cat #	Input Power	Lumen Output	LPW	Color Temp. (CCT)	CRI	Rated Life (L70)	Input Voltage	HID Equivalent	HID Equivalent
CLP-5001S-20CLED	25W	3,650	182	5000K	70+	>200,000	120-277V	50/60HZ	100w MH
CLP-5001S-40CLED	45W	6,492	162	5000K	70+	>200,000	120-277V	50/60HZ	150w HPS
CLP-5001S-50CLED	55W	7,780	155	5000K	70+	>200,000	120-277V	50/60HZ	250w MH
CLP-5001S-60CLED	65W	8,539	142	5000K	70+	>200,000	120-277V	50/60HZ	250w PSMH
CLP-5001S-70CLED	75W	9,986	142	5000K	70+	>200,000	120-277V	50/60HZ	250w HPS

Proudly Manufactured and Assembled in the USA

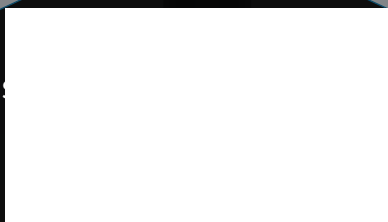
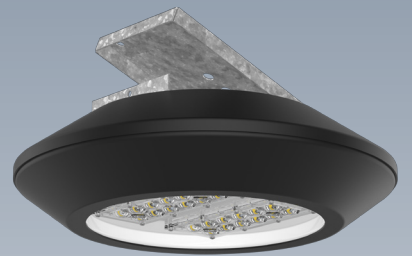

Proudly manufactured and assembled in the USA

Rev5/12/20