



Basic Data

Product Number	Wattage	Color Temp.	Voltage	Lumens	Working Hours	CRI
EX-20W B2YZDA	20	4000K-5700K	AC100-277V	2800	5 years	70
EX-40W B2YZDA	40	4000K-5700K	AC100-277V	5600	5 years	70
EX-60W B2YZDA	60	4000K-5700K	AC100-277V or AC200-480V	8400	5 years	70
EX-80W BYZDA	80	4000K-5700K	AC100-277V or AC200-480V	11200	5 years	70
EX-100W BYZDA	100	4000K-5700K	AC100-277V or AC200-480V	14000	5 years	70
EX-150W B3YZDA	150	4000K-5700K	AC100-277V or AC200-480V	21000	5 years	70
EX-180W B3YZDA	180	4000K-5700K	AC100-277V or AC200-480V	25200	5 years	70
EX-200W B3YZDA	200	4000K-5700K	AC100-277V or AC200-480V	28000	5 years	70

B,B2,B3 product code "Y"=D or N:Dimmable or non-dimmable "Z"= CCT, from 4000~5700K "D"=Beam angle, D40 for 40°,D60 for 60°,D90 for 90°, D120 for 120° A for glass info. blank for flat glass, C for spherical glass.

Dimensions

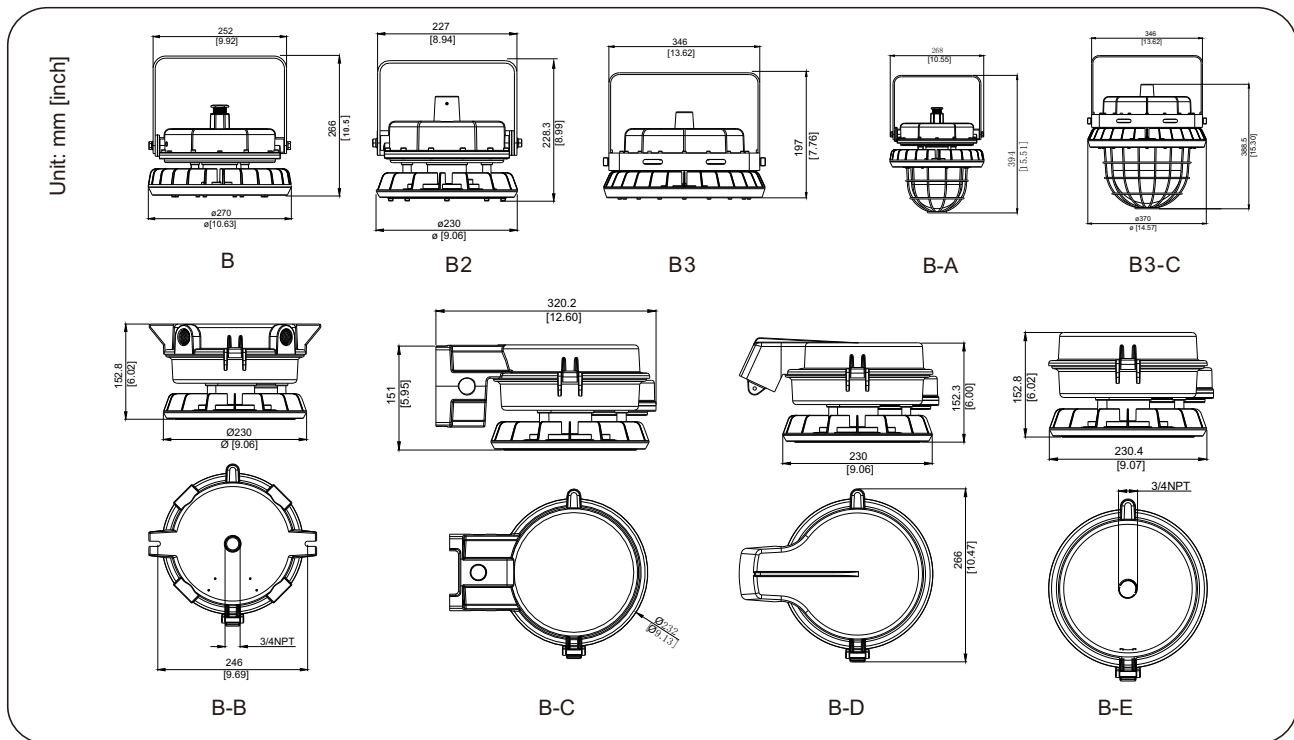

Lighting Distribution

200W/120D

Center Beam fc	Beam Width	
4ft	682fc	11ft
8ft	165fc	22ft
12ft	73fc	34ft
16ft	40fc	45ft
20ft	26fc	57ft

■ Vert, Spread; 120°
■ Horiz, Spread; 120°

200W/90D

Center Beam fc	Beam Width	
4ft	1004fc	8ft
8ft	244fc	15ft
12ft	109fc	24ft
16ft	62fc	32ft
20ft	39fc	39ft

■ Vert, Spread; 90°
■ Horiz, Spread; 90°

200W/60D

Center Beam fc	Beam Width	
4ft	1405fc	6ft
8ft	341fc	11ft
12ft	152fc	17ft
16ft	86fc	22ft
20ft	55fc	27ft

■ Vert, Spread; 60°
■ Horiz, Spread; 60°

200W/40D

Center Beam fc	Beam Width	
4ft	1967fc	4ft
8ft	477fc	7ft
12ft	213fc	11ft
16ft	120fc	15ft
20ft	77fc	19ft

■ Vert, Spread; 40°
■ Horiz, Spread; 40°

Installation

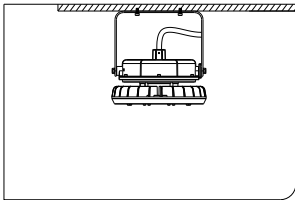

Ceiling Bracket Mounting

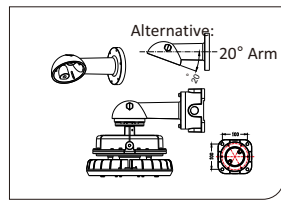

Alternative Arm Mounting

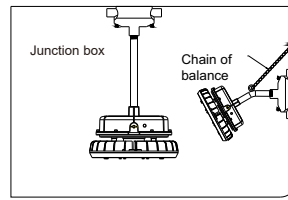

Pendant Mounting

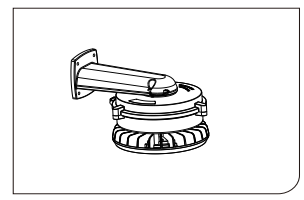

Arm Mounting

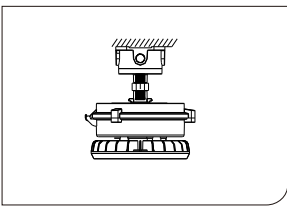

Junction Box Mounting

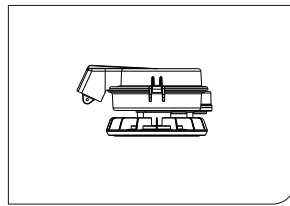

Stanchion Mounting

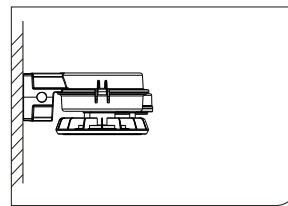

Direct Ceiling Mounting

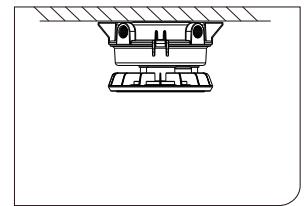

Direct Wall Mounting

Approvals

Marking Atex	II2 G Ex db IIB T6 Gb
	II2 D Ex db IIIC T80 Db IP66
Marking IECEX	Ex db IIB T6 Gb
	Ex db IIIC T80 Db IP66
Marking UL844 <small>(North American)</small>	Class I, Division 2, Groups A, B, C, D
	Class II, Division 1, Groups E, F, G
	Class II, Division 2, Groups E, F, G
	Class III
Marine Marking	UL 1598A
	ABS and DNV Type Approved
Other Rating	IP 66
	IK 10