

# Noribachi DLC *Zippy Kits!*

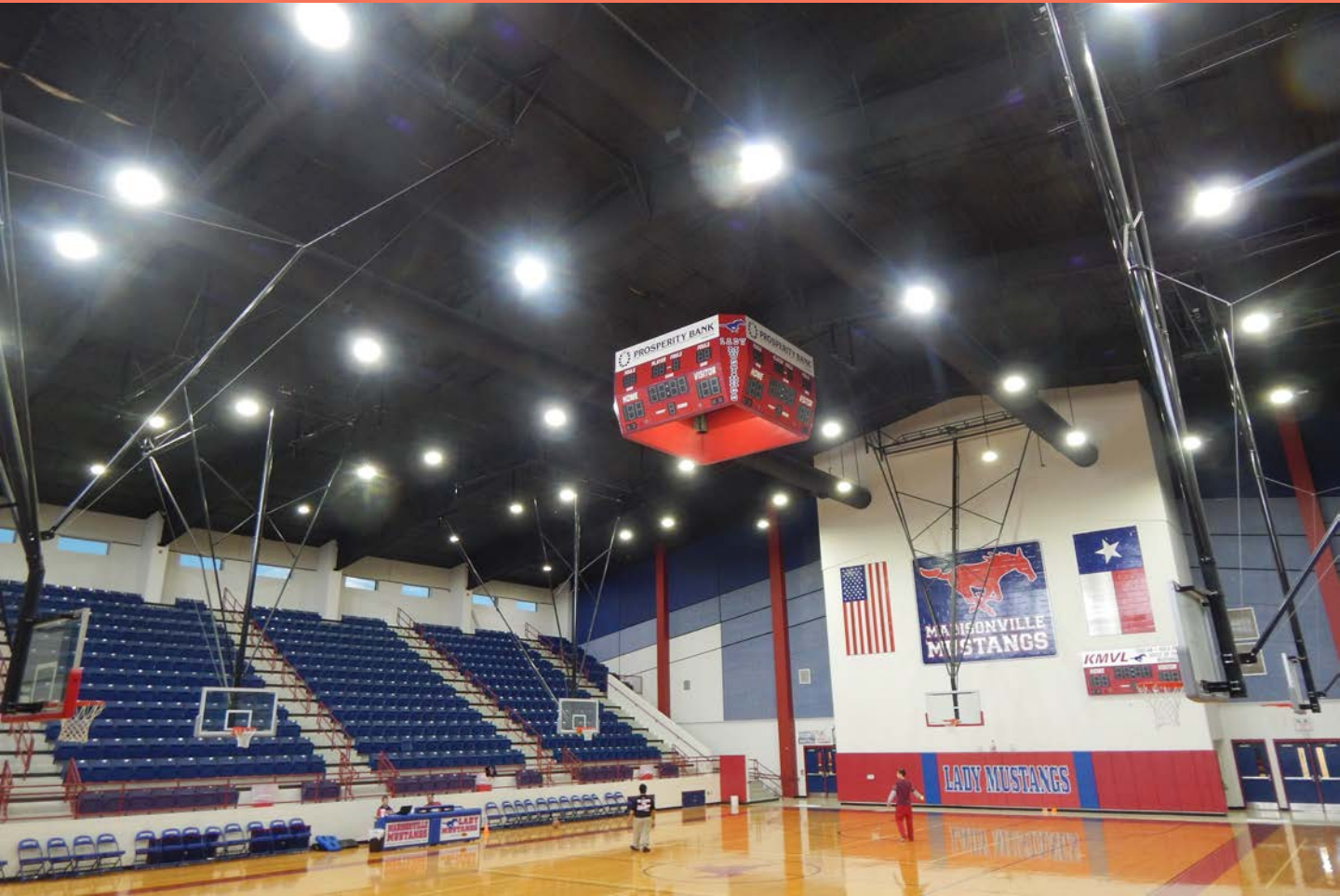

- Easy, flexible installation – no need for a custom plate!
- High lumen packages
- One for one replacement with HID, MH or HPS bulbs
- Best in the business efficacy
- Consistent color temperature

These are the only retrofit kits available on the market that comply with UL standard I598 out of the box! And they are on the DLC QPL!

Available in 72 Hours!  
Free Shipping!



# Noribachi DLC *Zippy Kits!*

## Common Applications

Catalog Number	Common Replacement For:	Area Lights	Bollard	Canopy	Cans	Cobra Head	Down Lights	Flood Lights	Post Tops	Wallpacks
L-C-CUS-21-REC-B-CW-MT	100W MH, 150W HPS	X	X	X	X	X	X	X	X	X
L-C-CUS-24-REC-B-CW-MT	150W MH	X	X						X	
L-C-CUS-42-REC-B-CW-MT	200W MH, 250W HPS	X		X	X	X	X	X	X	X
L-C-CUS-63-REC-B-CW-MT	250-400W MH	X		X	X	X	X	X	X	X
L-C-CUS-84-REC-B-CW-MT	400-500W MH	X			X	X	X	X	X	X
L-C-CUS-140-REC-B-CW-MT	700-1000W MH	X		X				X	X	
L-C-CUS-168-REC-B-CW-MT	750-1250W MH	X						X	X	
L-C-CUS-210-REC-B-CW-MT	1000-1500W MH	X						X	X	

## Physical Dimensions

Catalog Number	Mounting Plate Dimensions	Mounting Plate Shape	Fits Luminaires with Interior Dimensions of:			Weight (lbs.)
			Length	Width	Depth	
L-C-CUS-21-REC-B-CW-MT	4.75" dia.	circle	5" – 13"	5" – 13"	3" (min)	1.25
L-C-CUS-24-REC-B-CW-MT	2" dia.	cob	3" (min)	3" (min)	8" (min)	0.7
L-C-CUS-42-REC-B-CW-MT	8" dia.	circle	8.25" – 20.5"	8.25" – 20.5"	3" (min)	3.42
L-C-CUS-63-REC-B-CW-MT	11"W x 11"L	square	11.25" – 30.25 "	11.25" – 30.25 "	4" (min)	5.04
L-C-CUS-84-REC-B-CW-MT	11"W x 11"L	square	11.25" – 30.25 "	11.25" – 30.25 "	4" (min)	5.15
L-C-CUS-140-REC-B-CW-MT	12"W x 14.25"L	rectangle	14.5" – 39"	12.25 - 33"	5" (min)	7.23
L-C-CUS-168-REC-B-CW-MT	20"W x 20"L	square	20.25" – 30.25 "	20.25" – 30.25 "	5" (min)	9.9
L-C-CUS-210-REC-B-CW-MT	20" dia.	round	20.25" – 30.25 "	20.25" – 30.25 "	5" (min)	12.24

## Electrical Characteristics

Catalog Number	Drive Current		
	Amps @ 120V	Amps @ 277V	Amps @ 480V
L-C-CUS-21-REC-B-CW-MT	0.26	0.11	0.07
L-C-CUS-24-REC-B-CW-MT	0.3	0.13	0.07
L-C-CUS-42-REC-B-CW-MT	0.53	0.23	0.13
L-C-CUS-63-REC-B-CW-MT	0.79	0.34	0.2
L-C-CUS-84-REC-B-CW-MT	1.05	0.46	0.26
L-C-CUS-140-REC-B-CW-MT	1.76	0.76	0.44
L-C-CUS-168-REC-B-CW-MT	2.12	0.92	0.53
L-C-CUS-210-REC-B-CW-MT	2.66	1.15	0.67



# Noribachi DLC *Zippy Kits!*

**Performance Summary**

CRI: Minimum 70 CRI. Custom CRI available upon request.  
 CCT (Typical): 5200K  
 Manufactured in the U.S. with parts from U.S. and imported.

**Electrical System Characteristics / Data**

Standard AC input: 120-277 VAC  
 EMI filter: 47CFR, part 2, part 15  
 Power factor: >0.9  
 Total harmonic distortion: <20%  
 Surge protection: IEC/EN 61000-4-5 EMC test standard

**Electrical System**

Surge protection meets 10KV/5KA per ANSI/IEEE62.41. Driver meets maximum harmonic distortion (THD) of 20% and is ROHS compliant. Power Factor = > 0.9.

**CIE LUV BINNING CURVE**  
 LIN-140 CIE 1932 – 2 Degree

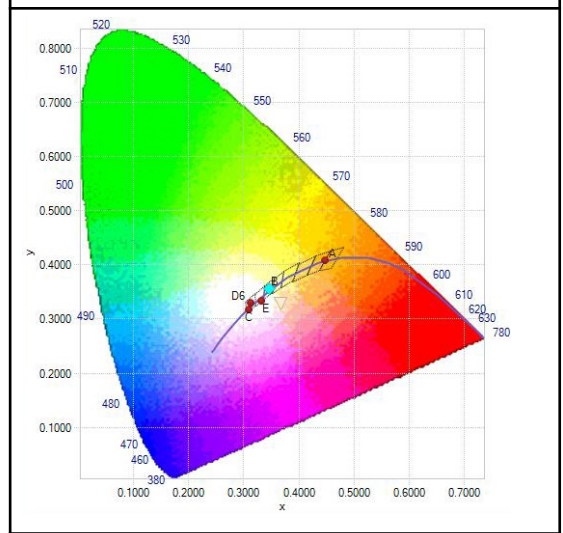

**Mounting**

All kits come with a package of hardware that precludes the use of a custom plate. Mounting kits include several different sized, fully adjustable magic-tabs, a collection of wire connectors, fastening hardware, spacers and zip-ties.

**Controls**

0-10V (010V) Dimming included.

**Testing Compliance**

UL SUBJECT 1598C Issue:2011/05/31 Outline of Investigation for Light-Emitting Diode (LED) Retrofit Luminaire Conversion Kits - Issue No. 2 UL 1598C Issued: 2008/09/17 Ed:3 Rev:2012/10/17 UL Standard for Safety Luminaires CSA C22.2#250.0- Issued: 2008/09/17 Ed:3 Luminaires; General Instruction No.1 2010/01/11, General Instruction No. 2 2012/10/17

**Ordering**

In stock and ready to ship in 72 hours!



# Noribachi DLC *Zippy Kits!*

## Physical Dimensions – L-C-CUS-21-REC-B-CW-MT

Includes a universal mounting kit with four 2.5" and four 4.75" magic tabs.

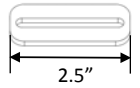
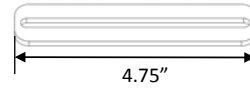
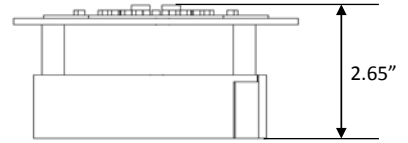
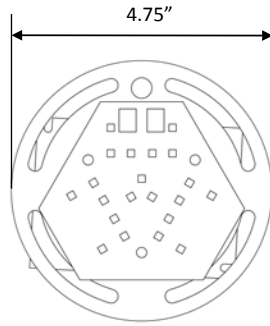
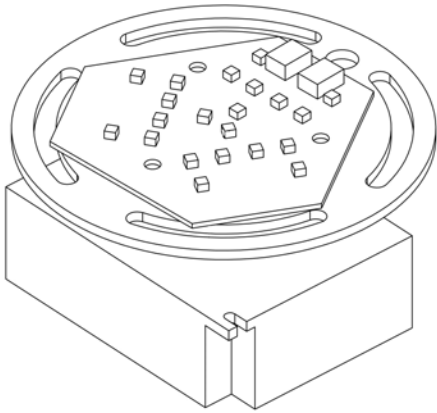

## Physical Dimensions – L-C-CUS-24-REC-B-CW-MT

Includes a universal mounting kit with 6" all-thread.

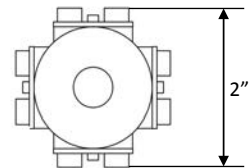
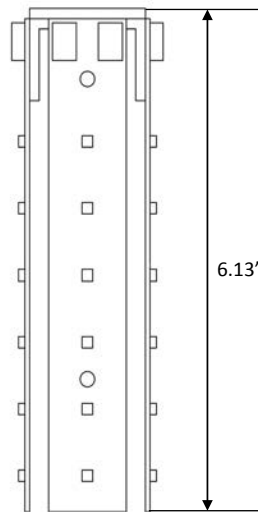
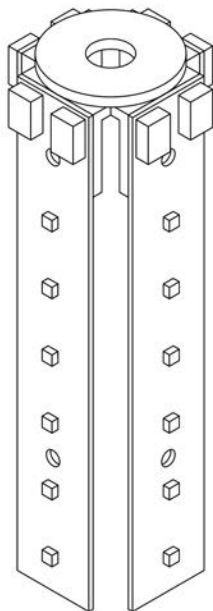

# Noribachi DLC *Zippy Kits!*

## Physical Dimensions – L-C-CUS-42-REC-B-CW-MT

Includes a universal mounting kit with four 2.5", four 4.75" and four 7.5" magic tabs.

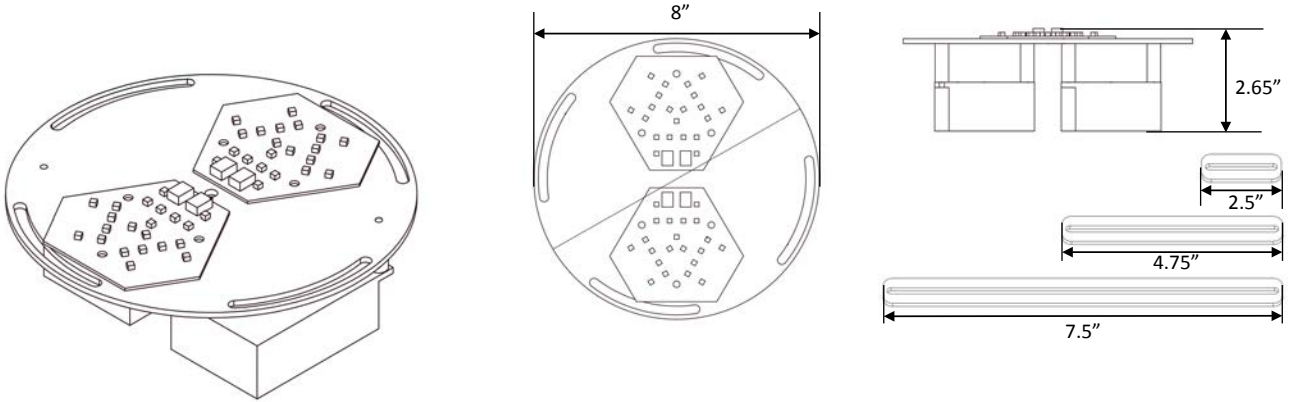

## Physical Dimensions – L-C-CUS-63-REC-B-CW-MT

Includes a universal mounting kit with four 2.5", four 7.5" and four 11" magic tabs.

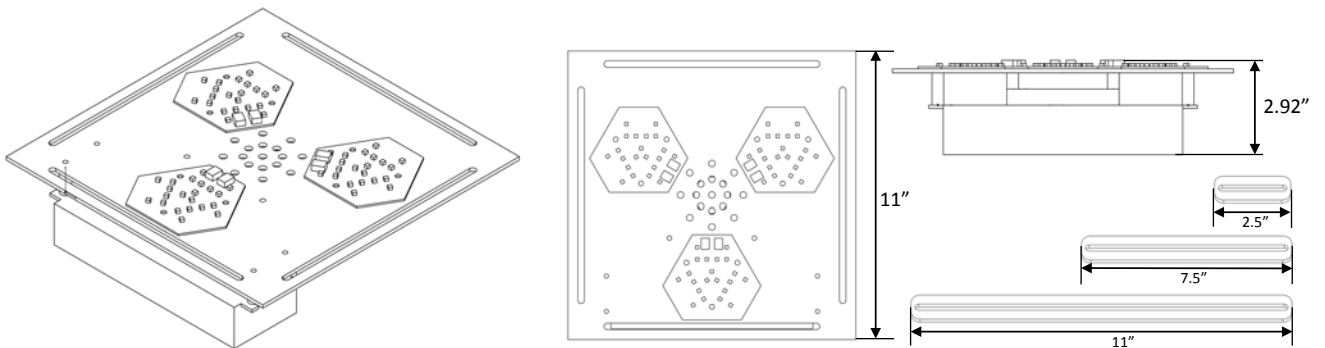

# Noribachi DLC *Zippy Kits!*

## Physical Dimensions – L-C-CUS-84-REC-B-CW-MT

Includes a universal mounting kit with four 2.5", four 7.5" and four 11" magic tabs.

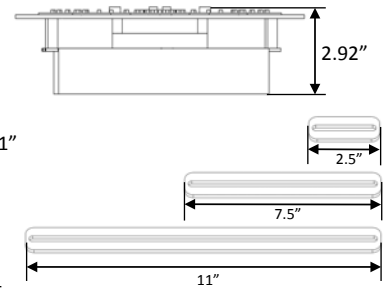
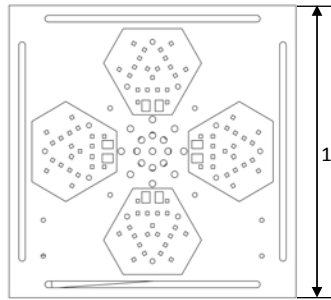
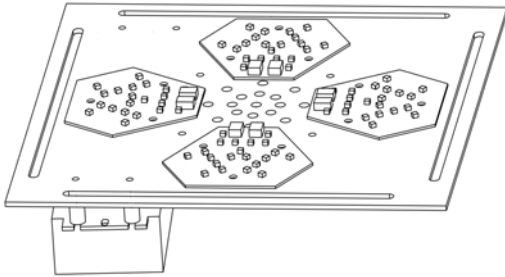

## Physical Dimensions – L-C-CUS-140-REC-B-CW-MT

Includes a universal mounting kit with four 2.5", four 7.5" and four 14.25" magic tabs.

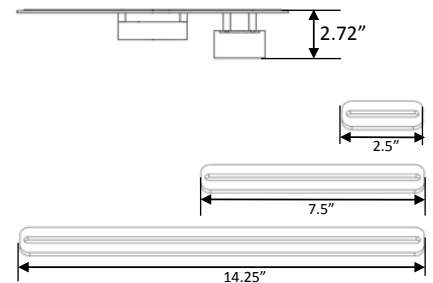
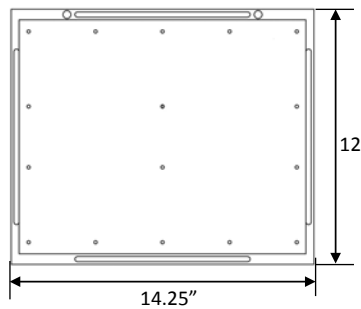
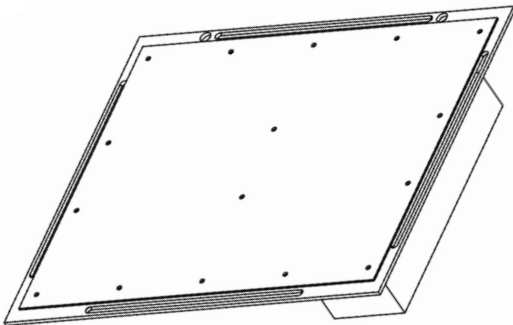

# Noribachi DLC *Zippy Kits!*

## Physical Dimensions – L-C-CUS-168-REC-B-CW-MT

Includes a universal mounting kit with four 2.5", four 11" and four 20" magic tabs.

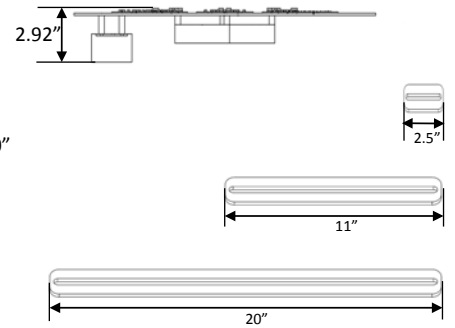
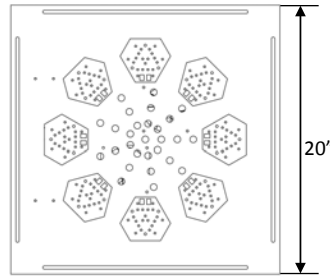
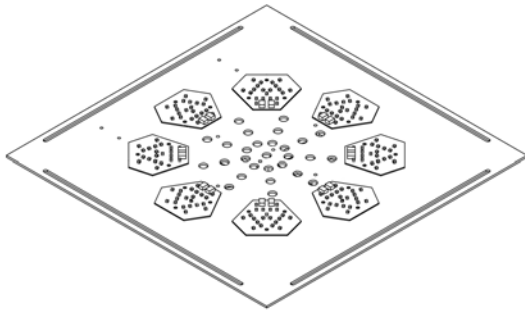

## Physical Dimensions – L-C-CUS-210-REC-B-CW-MT

Includes a universal mounting kit with four 2.5", four 11" and four 20" magic tabs.

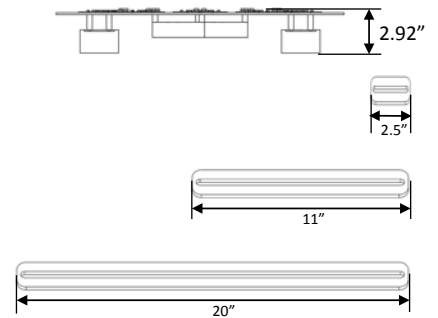
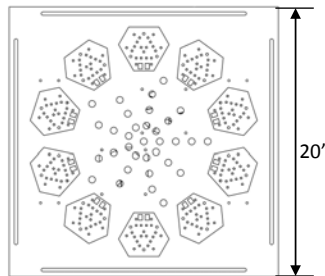
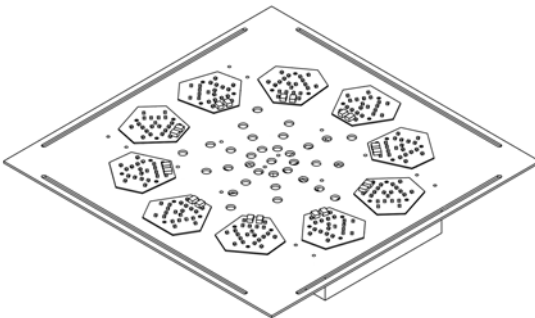

# Noribachi DLC *Zippy Kits!*

Now, you can also buy the individual components that go into the Zippy Kits. NOTE: Items on this page are not on the DLC QPL.

## LED Common Lighting Units (CLUs)

Catalog Number	Number of LEDs	Board Type	Board Dimensions			Finish	Material	Type
			Thickness	X	Y			
<b>CLU - LIN</b>	7	ENG	0.062	1	6	Cu 4 OZ	Aluminum Metal Core	Black LPI
<b>CLU - HEX</b>	21	ENG	0.062	3.75	3.25	Cu 4 OZ	Aluminum Metal Core	Black LPI
<b>CLU - SQUARE</b>	140	ENG	0.062	11	13.5	Cu 4 OZ	Aluminum Metal Core	Black LPI

### CLUs

All Noribachi Common Lighting Units (CLUs) use high brightness LEDs (efficacy > 130 lm/watt).

When ordering, specify CW (5700K), NW (4000K), or WW (3000K). For example: CLU-LIN-CW.

Other LED types, including RGB, are available.

Only for use in dry locations.

Three month warranty.

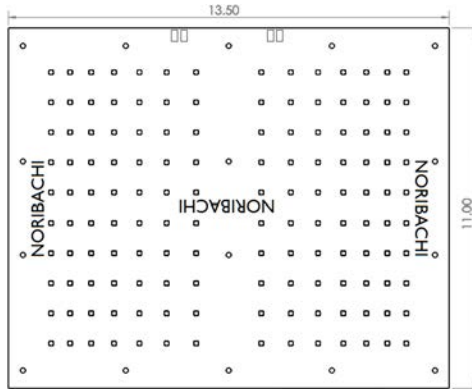

**CLU-SQUARE: 140 LEDs**

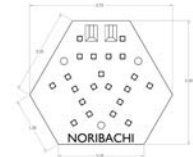

**CLU-HEX: 21 LEDs**



**CLU-LIN: 6 LEDs**

## LED Drivers

Catalog Number	AC Driver Wattage	DC Current (A)	Input Voltage	Dialable?
<b>DRIVE-25</b>	25	1.05	90-305VAC	No
<b>DRIVE-40</b>	40	1.67	90-305VAC	No
<b>DRIVE-67</b>	67	2.8	100-277VAC	No
<b>DRIVE-100</b>	100	4.1	120-277VAC	No
<b>DRIVE-150</b>	150	6.3	90-305VAC	Yes
<b>DRIVE-240</b>	240	10	90-305VAC	Yes

### Drivers

All Noribachi drivers are UL recognized.

Only for use in dry locations.

Three month warranty.

