

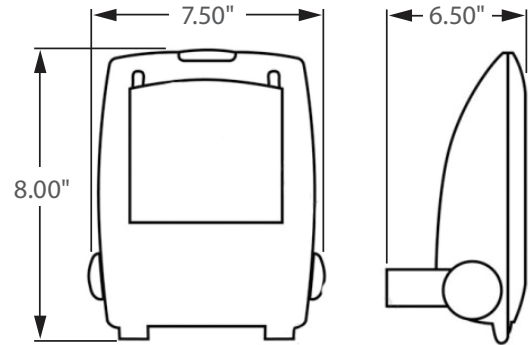

**** AVAILABLE ****
0 - 10V
FULL DIMMING



Incredible **75,000** hrs

GENERAL DESCRIPTION

Neptun's LED Flood fixtures feature classic form and durability to make it an excellent choice for new construction or retrofit applications. Neptun's LED-61 series fixtures feature high output LED's and custom engineered optics to provide excellent uniformity and efficiency. It can replace existing HID & HPS fixtures up to 70 Watts.

APPLICATION

- Building Accent Lighting
- Landscape Lighting
- Security Lighting
- Parking Lot Lighting
- Area Lighting
- Storage Area Lighting
- Sign Lighting

STRUCTURE, MATERIALS, & FEATURES

- Heavy-gauge, die-cast aluminum housing.
- Heat and impact resistant tempered glass lens with anti-glare diffuser.
- Corrosion resistant electrocoat finish (custom colors available).
- Continuous silicone gasket surrounds lens for weather - tight seal.
- Tool-less entry design for easy maintenance and installation.
- Adjustable yoke bracket mounting included.
- High Output COB LED's.
- High power factor, low THD driver with 10kV Surge Protection.
- InstantON flicker-free Cold Start and Hot Re-Start.
- Up to 15 years Maintenance free operation.
- 5 Year Warranty on complete fixture. (LED's, Driver, & Housing)
- **Optional:** 0-10V Dimming, Remote Monitoring and ON/ OFF Control, DC 24V Operation - Solar Compatible

ORDERING INFORMATION

Sample Number: LED-61020-UNV-0-10VDIM-850-B60-GRY
 Custom options and accessories available. Please consult factory

Series	Wattage	Voltage	Options	Color Temp	Beam Spread	Color
LED-61 = Flood Light	020 = 20W	UNV = 120-277 VAC 347V = 347 VAC 480V = 480 VAC 24VDC = 24 VDC	0-10VDIM = 0-10V Dimming * Contact Factory for Dimming options	835 = 3500°K 841 = 4100°K 850 = 5000°K * * Standard	B45 = 45° Beam B60 = 60° Beam B90 = 90° Beam	GRY = Grey BRZ = Bronze BLK = Black * Custom Colors Available



PRODUCT INFORMATION

Model No.	Description	Rated Watts	Input Watts	Initial Lumens	Universal Line Voltage (VAC)	Max Line Current (Amp) @ 120 - 277	THD	Power Factor	Weight
LED-61020-UNV	LED Flood Fixture	20	21	1,800	120-277	0.17 - 0.07	<20%	>0.90	8 lbs

SPECIFICATIONS

- Driver Constant Current
- Start Method InstantON
- Hot Re-start InstantON
- Power Supply 350mA
- Driver UL Rating Class 1
- Driver UL Outdoor Rated Wet Location
- Sound Rating Class A
- ANSI Surge Protection IEEE C62.41 C High
- Driver Off-State Draw 0 Watts
- Universal Input Line Voltage 120-277 VAC
- Input Line Frequency 50/60 Hz
- LED / Driver System Life 75,000 Hrs.
- Lumen Maintenance @50,000Hrs > 70%
- Color Temperature 5,000°K
- Color Rendering Index (CRI) > 80
- Beam Angle 45° / 60° / 90°
- Minimum Starting Temperature -40°C
- Maximum Starting Temperature +50°C
- Lumens per Watt > 90
- Shock / Vibration Resistant Yes
- Power Factor > 0.90
- Total Harmonic Distortion < 20%
- Inrush Current Peak < 10 Amp
- FCC Compliance Part 15, Subp. C
- Housing IP Rating IP65
- Driver IP Rating IP67
- Warranty 5 Year

MOUNTING OPTIONS

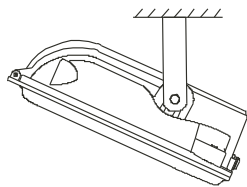

Ceiling Mount

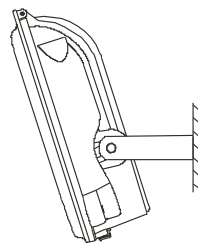

Wall Mount

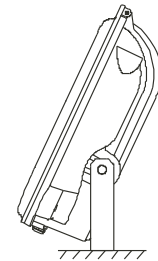

Ground Mount

PHOTOMETRICS (See Complete IES File)

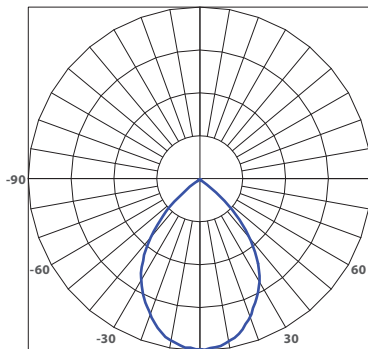

90° Beam (B90)

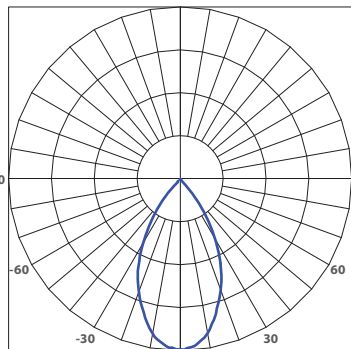

60° Beam (B60)

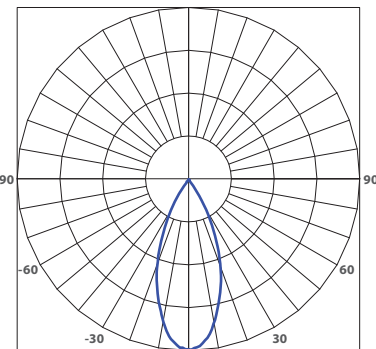

45° Beam (B45)